



Welcome to BricsCAD®

An innovative and cost-effective DWG-based CAD platform for 2D, 3D, BIM and mechanical design

TRY IT FOR FREE FOR 30 DAYS

www.thedesignsense.com

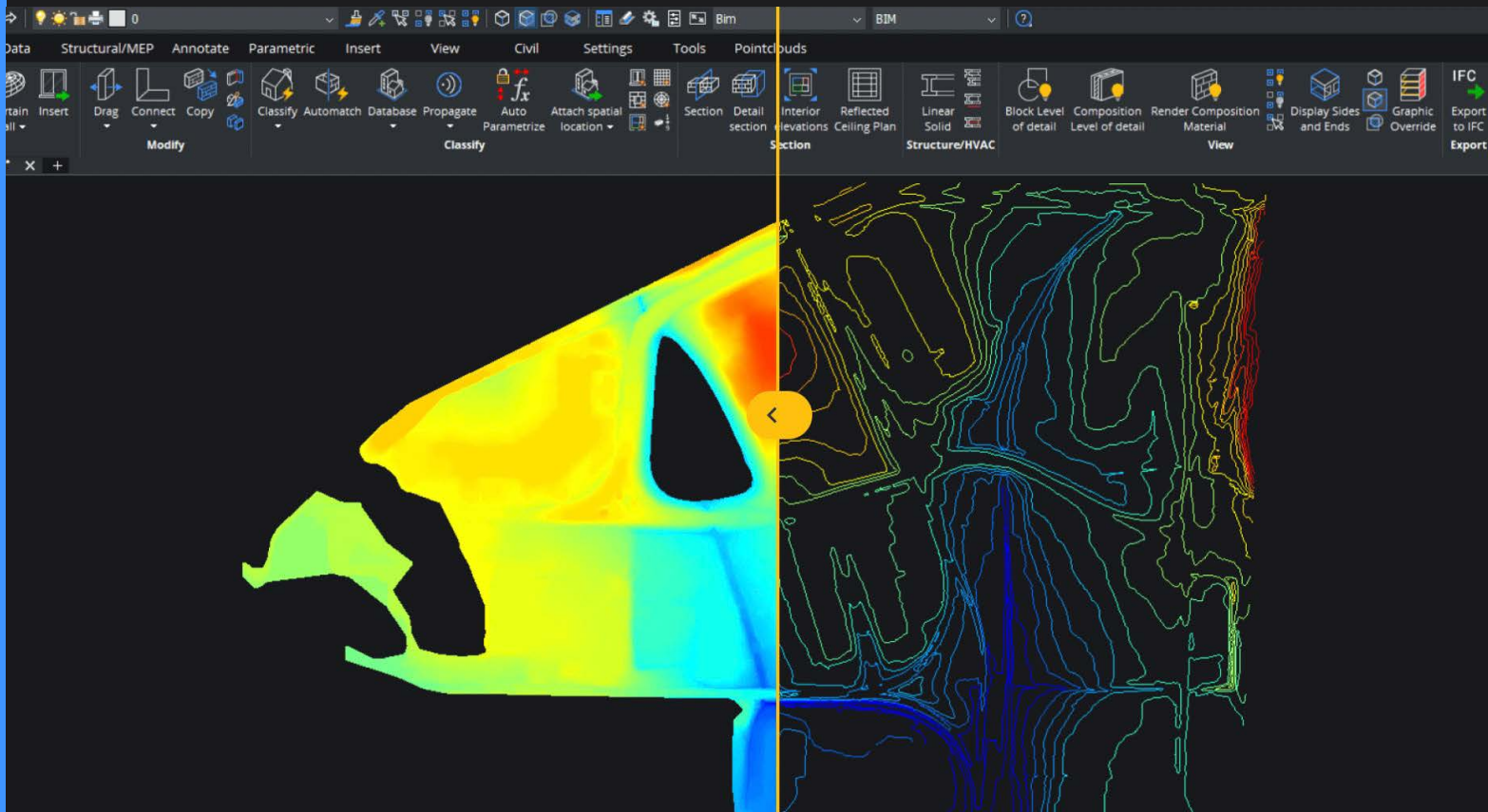

Powerful and affordable 2D drafting software

For anyone who need fast, accurate and affordable documentation

Well-known 2D Drafting Tools

BricsCAD offers all the 2D drafting tools you know, and more. You can access them directly from the ribbon, toolbars or the command line. Current CAD users can be comfortable with BricsCAD in an hour, and proficient in an afternoon.

Familiar interface

Leverage what you already know with full command, script, macro and menu compatibility with AutoCAD®

- Command compatible
- Menu (.CUI, .CUIX) compatible
- Macro/script compatible
- Support file (.PC3, .LIN, .PAT, .DWT, .SSM) compatible

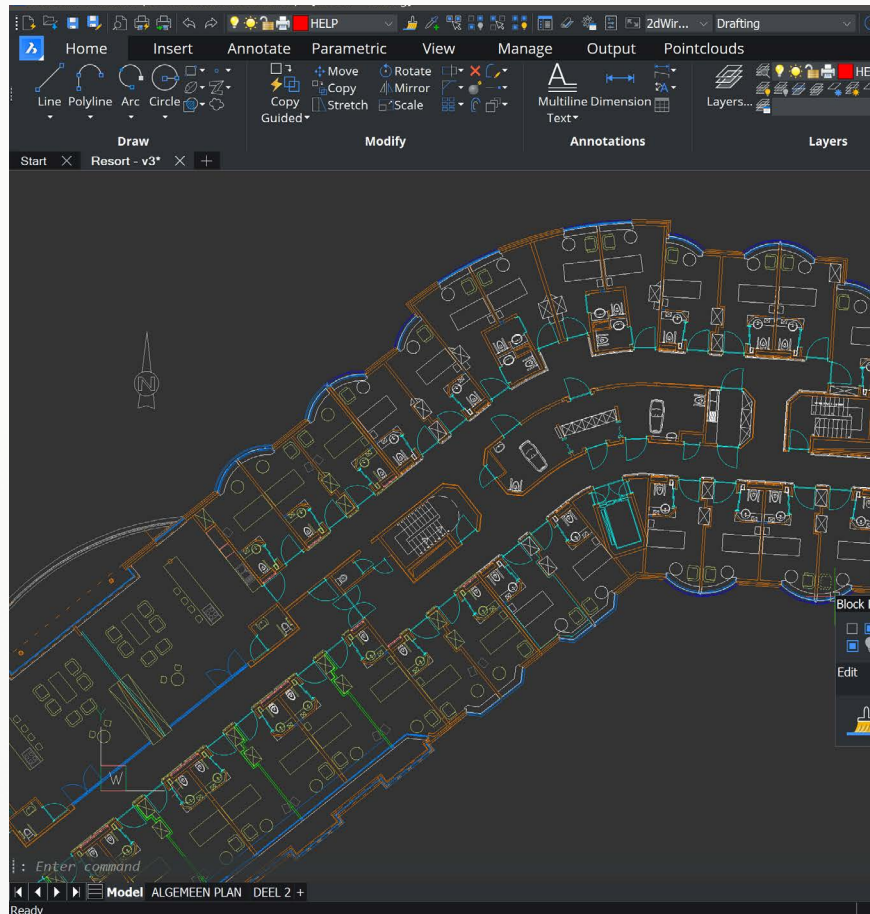

Highly compatible

There's no need to change your printer setup, drawing templates, blocks or sheet set layouts to move to BricsCAD – they are all 100% compatible. BricsCAD is based on native DWG for the highest compatibility.



Powerful LISP Interpreter

Run LISP routines developed in other CAD applications or develop your own in the BricsCAD LISP Advanced Development Environment (BLADE).



Use your Dynamic Blocks

You can use the Dynamic Blocks that you created in AutoCAD® directly inside of BricsCAD. Control visibility states, stretch, flip, rotate and alignment.



Convert repeated geometry into blocks



Blockify automatically creates a block definition and replaces all matching sets of entities with block references throughout your entire drawing.



"BricsCAD is very fast and very stable. One of the things that we like about BricsCAD is that we can work with large files."

Jose Duarte - Civil Engineer at Noraqua

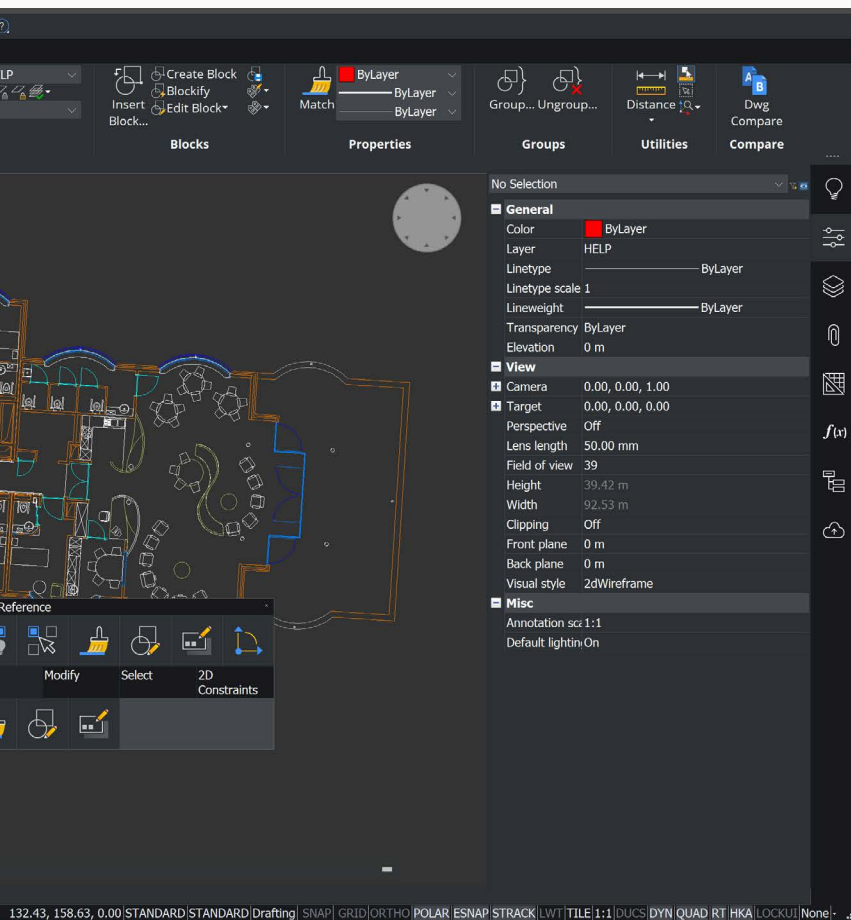

Tools for CAD Managers

Our standards checking toolkit can assist with data migration, and can better refine and standardize your drawings for sharing and collaboration.

Quad

BricsCAD's unique Quad palette predicts your command usage and offers one-click access to the command you'll need next.



Nearest Distance ⚡ A.I.

View the distance between any two entities, and move the second one by simply typing in a new distance value.



Copy Guided ⚡ A.I.

Copy Guided automatically aligns copied entities to relevant geometry using automatically generated guide curves for both 2D and 3D data.



High performance

BricsCAD supports multi-threaded, multi-processor operations to speed product performance for file loads, drawing generation and rendering.



PDF & BigTIFF underlays

We use a multi-resolution, persistent image cache to display PDF underlays, enabling super-fast zoom and pan operations, even with enormous 64-bit BigTIFF files.

Modern 2D drafting and 3D modeling software

For users who need the flexibility of 2D or 3D CAD to help solve their design problems faster

2D Drafting & 3D Modeling Tools

In addition to the comprehensive 2D drafting tools that BricsCAD is known for, BricsCAD® Pro includes our powerful 3D Direct Modeler. Start with 3D shapes, then push & pull faces or vertices to create your model. You can also sketch 2D profiles and extrude, sweep or revolve them into 3D solids.

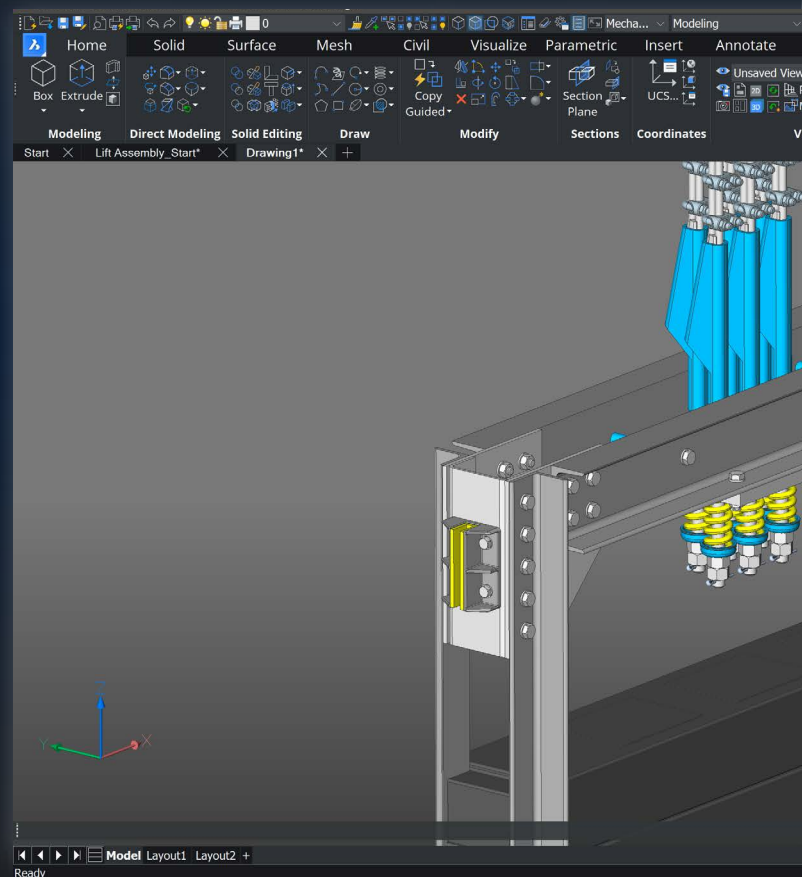

Parametric Blocks

Parametric blocks automate repetitive tasks by enabling fast drawing creation, changes and reconfigurations. They allow you to create one block and reuse the geometry in an intelligent and adaptable way.



Civil Engineering tools

BricsCAD® offers a range of civil design tools for creating and editing TIN surfaces, grading, and alignments as well as boundary trim and corridor editing. BricsCAD® is interoperable with Civil 3D drawings and other GIS and mapping data.



Easy drawing generation

Automatically generate associative orthographic and standard isometric views of your 3D models, with full control over the layout and style of the views. Then, use the powerful detailing tools in BricsCAD® to document your designs.



Point Clouds

Point cloud visualization tools in BricsCAD® Pro support industry-standard point cloud formats, and let you navigate massive point clouds smoothly and quickly. Our intelligent PointCloud filtering enables users to generate workable TIN surfaces without loss of accuracy.



"The volume of 3D modeling work is increasing every day and BricsCAD supports a smooth transition from 2D CAD to 3D CAD."

Masahiro Abe,
Production Engineering Division at Mazda

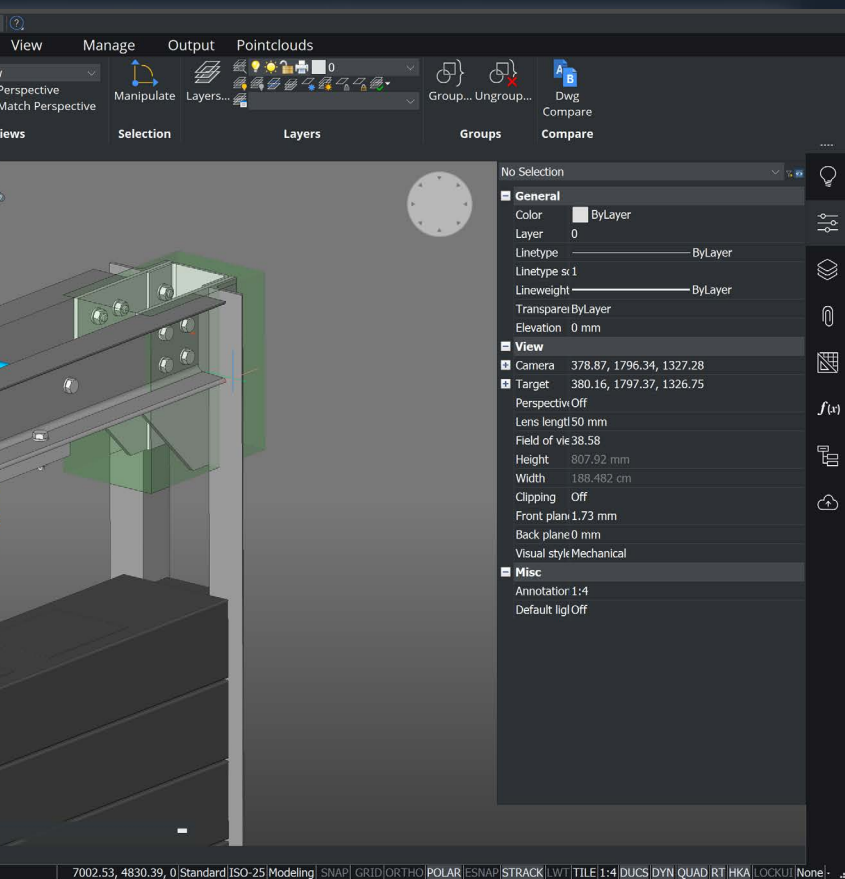

Familiar interface / menus

Leverage what you already know with full command, script, macro and menu compatibility with AutoCAD®

- Command compatible
- Menu (.CUI, .CUIX) compatible
- Macro/script compatible
- Support file (.PC3, .LIN, .PAT, .DWT, .SSM) compatible

+ 3rd PARTY APPLICATIONS

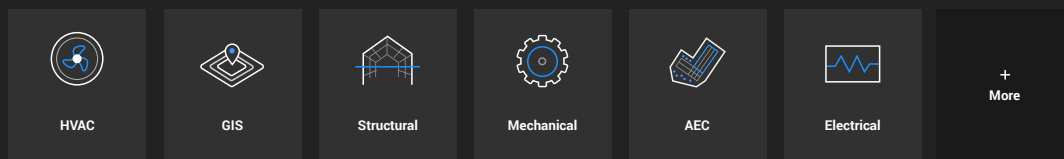

The BricsCAD Runtime eXtension (BRX) API enables top application developers to build industry-specific tools and workflows for BricsCAD. With powerful C++ and .NET APIs, BricsCAD is highly compatible with the APIs of legacy DWG-based products. We offer over 400 third-party applications on the Bricsys Application Store to help you get your work done easier, faster and more accurately.

A.I.- powered Building Information Modeling software

For designers, architects and engineers working in the building industries

Design with solids

Experience design freedom with a 3D workflow, not limited by pre-defined parts or library components. Use intuitive push-pull Direct Modeling to sculpt your massing model. Your model remains light and responsive, because it's not over-loaded or over-constrained.

Automate Increased LOD

BricsCAD BIM's A.I. workflows help automate a continuous increase in Level of Development. Convert your concept study model to a fully classified BIM at LOD 200. Continue to increase the LOD with our PROPAGATE workflow – model details once, then use them across the entire BIM, automatically.

Scan-to-BIM

Capture point cloud as-built information during different phases of construction and renovation projects. Our smart features can create model geometry from the data or enable users to analyse deviations from the original designs.

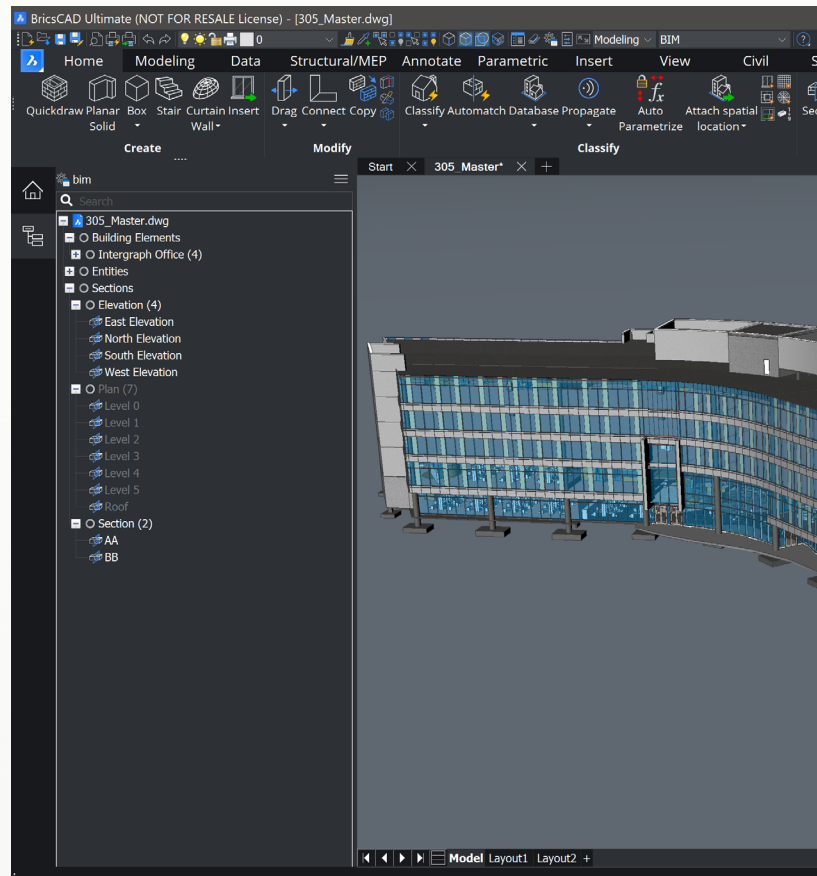

Detailing & quantification

Increase your model's LOD by adding information and duplicating it at any or all matching instances across your BIM, automatically. With high accuracy and consistent Level of Detail across the entire BIM, exact quantity takeoffs and Bills of Materials can be extracted, displayed and exported.

Generate spectacular documentation

Create clear and accurate construction documentation in record time, using the automatic generation of sections, elevations, drawing views and sheet layouts. Change your 3D model, and all associated drawing views will be regenerated automatically to stay in total sync.



"By converting building plans into a BIM model, we can provide more precise advice to our suppliers, and accurately calculate material quantities. By checking the design models and eliminating errors in the preparation phase, we avoid failure costs and the associated loss of time during implementation."

Dieter Froyen
Head of Work Preparation Construction, Willemen Construct

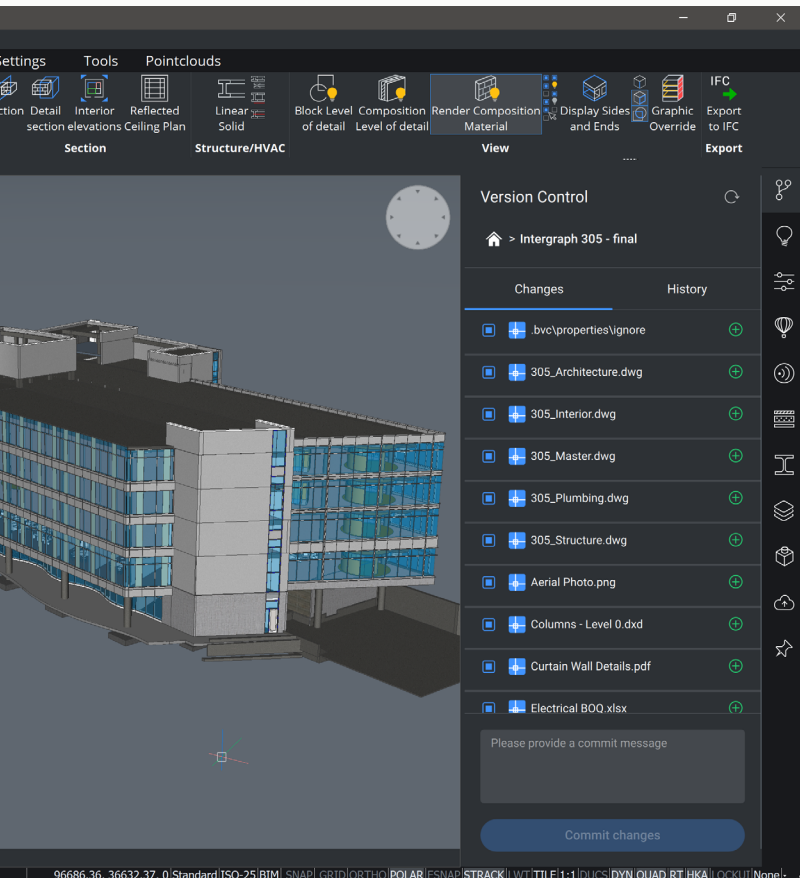

Collaborate freely

BricsCAD BIM supports global, open standards to ensure smooth collaboration with everyone on the extended design/build team. Add Bricsys 24/7, our SaaS-based Common Data Environment (CDE), as the hub for model sharing and project communications.

-  IFC 4.0 and BCF
-  Read Revit Files
-  Import directly from Trimble SketchUp

Project Browser

Manage project data and drawings with the Project Browser. Store drawings, images, spreadsheets, or algorithms that streamline your workflow, all in one place.

Deliver custom designs for Manufactured Building Products

The accuracy of BricsCAD BIM offers new horizons for manufacturers of building products. Custom components can be designed and shared as assemblies, for use within the BIM or on the shop floor for fabrication.

Visualize

Visualize your design at every phase of the workflow with BricsCAD BIM and walk through your fully rendered model project. With a single click, you can start real-time rendering using Enscape or Lumion, or with Twinmotion using a built-in direct link.



Advanced mechanical design tools

For mechanical engineers and product designers

Bills of materials generation

The BOM panel lets you manage multiple Bills of Materials, as tables in your drawings. You can format columns, set up equations, sort entries, and more.

Flexible assembly design

BricsCAD Mechanical users can create complex hierarchies of parts and sub-assemblies using bottom-up or top-down design methods. You can import assemblies from different CAD systems using Communicator for BricsCAD, including Parametric geometry defined in those assemblies.

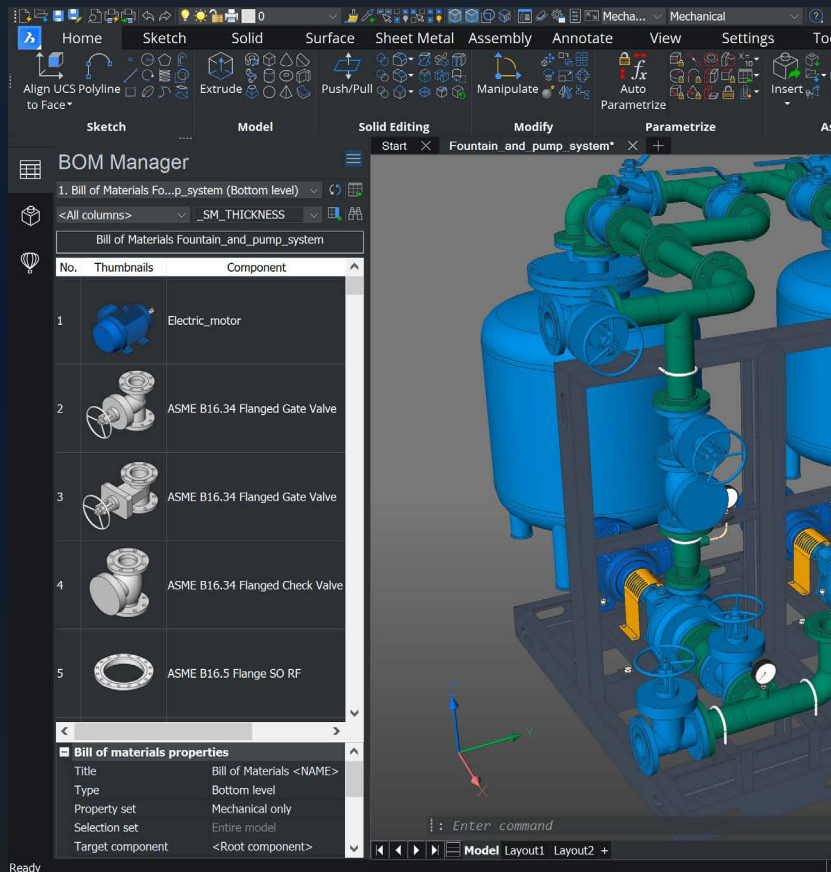

3D Constraints

The powerful 3D constraint engine in BricsCAD Mechanical helps you create parametric components, including table-driven parts and assemblies.



Parametric standard parts

BricsCAD contains a library of more than 1,000 parametric mechanical parts grouped into four categories: Fasteners, Machine Parts, Structural Shapes and Piping. ANSI, ASME, DIN, ISO and JIS standard are supported.



Automated Drawing Generation

Experience a familiar workflow for the creation of drawing layouts. Change a single part or the entire assembly, and all 2D drawing views are automatically updated.



Automated Exploded views with trailing lines

BricsCAD Mechanical can create multi-axis exploded views, automatically disassembling complex assemblies and adding trailing lines, in just one click.

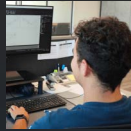

"BricsCAD Mechanical has enabled our team to set even higher standards for structural and mechanical drawings"

**Melvin Hamar,
Engineer at Asto Shipyard**

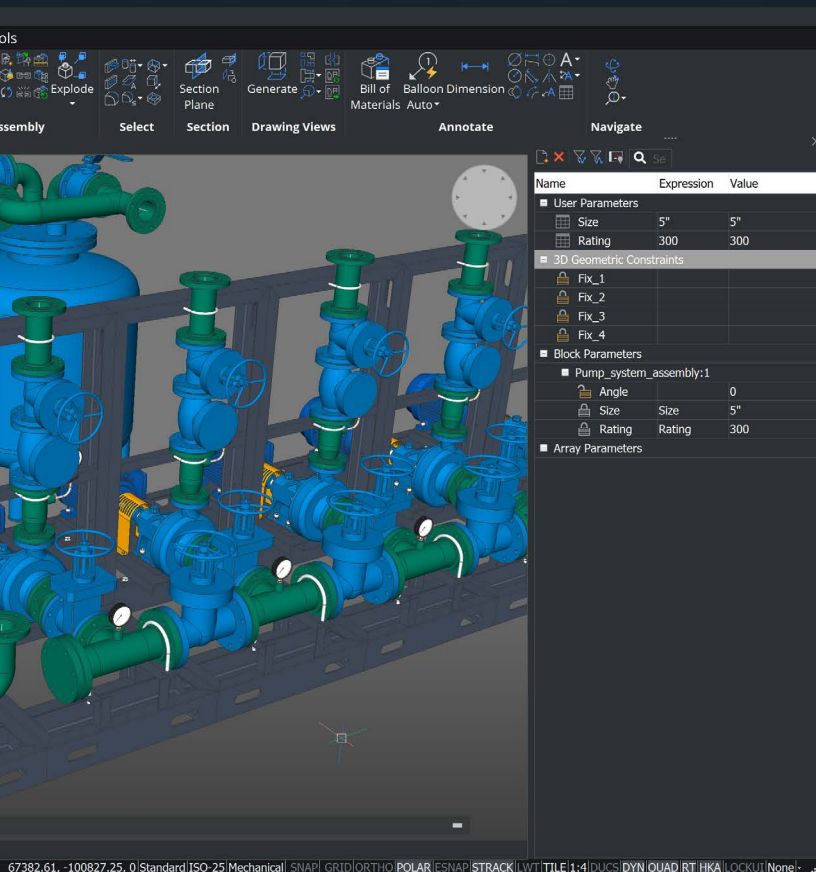

Part design

BricsCAD's unique variational 3D modelling approach gives you the freedom to design how you want to, from concept to detail, with whatever level of parametric control you need. Quickly develop complex components on their own, or directly within an assembly.

Custom Properties

Our custom properties field improve understanding of assemblies, components and BoMs, for more effective downstream communication.

Sheet metal design

BricsCAD Mechanical lets you import or create sheet metal parts using lofted solids, using our one-click automated feature. Our range of specific sheet metal tools enables design iteration and reduces design-time improving overall efficiency.



Smarter piping design

Our smart placement feature automatically inserts the correct size valve or flange, in the right position and updates when one parameter is changed.



Communicator for BricsCAD®

Communicator for BricsCAD is an extra-cost module that works with BricsCAD Pro, BIM and Mechanical

Communicator for BricsCAD seamlessly imports geometry and PMI data from major CAD programs, and exports industry-standard 3D file formats.

Import & export files from:

- ACIS
- Parasolid
- CATIA™
- Creo
- IGES/ STEP
- Siemens NX
- SOLIDWORKS®
- Autodesk® Inventor
and more

BricsCAD® Ultimate

One continuous workflow

BricsCAD Ultimate is our all-in-one solution for designers, engineers, manufacturers, and contractors. It brings our CAD and BIM software together into one bundle, so multi-disciplinary organizations can benefit from a continuously developing workflow to work better together.

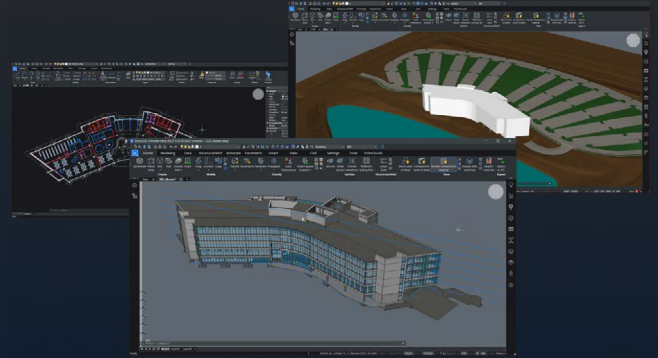

One platform

Move from concept to creation with all the tools you need to design, build and manufacture, all in one platform.

Compatibility

Improve productivity and remove errors with our single DWG file format for all technical disciplines.

Network licenses

With our shareable networked licence, you can buy or subscribe to BricsCAD Ultimate, and have complete flexibility across our CAD, BIM & Mechanical software, ensuring you have the right tool for the task.



BricsCAD® Maintenance

An optional yearly fee that keeps your perpetual product licenses up to date with all BricsCAD product releases and more. It is the least expensive way to stay current with the newest product features and workflows.



Enjoy the absolute lowest cost of ownership and all the latest features



Get product updates and major BricsCAD releases



Fast priority product support when you need it

Solutions with our partners



BricsCAD® for Civil

Civil infrastructure design

Quickly create and modify TIN surfaces, gradings, and alignments for site design.

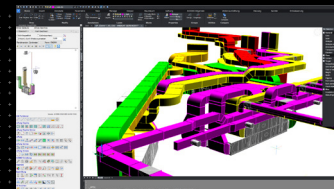

BricsCAD® for MEP

Building Mechanical, Electrical and Plumbing Engineering

BricsCAD supports an end-to-end workflow, from schematics through analysis, to BIM



BricsCAD® for Visualization

Real-time rendering and model visualization

Explore your models at any phase in the workflow with BricsCAD and the industry leaders in rendering software

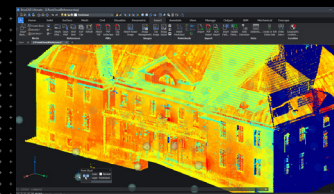

BricsCAD® for Point Clouds

A unique Point Cloud workflow

Rapidly import scan data, visualize as-builts, and guide 3D model creation

Which BricsCAD® is right for you?

Understanding the BricsCAD® Editions

	BricsCAD Lite	BricsCAD Pro	BricsCAD Mechanical	BricsCAD BIM	BricsCAD Ultimate
Tools for CAD Managers	✓	✓	✓	✓	✓
Re-use your AutoCAD Customizations	✓	✓	✓	✓	✓
100% Real DWG	✓	✓	✓	✓	✓
Powerful, Compatible Lisp API	✓	✓	✓	✓	✓
2D Constraint Manager	✓	✓	✓	✓	✓
3D Direct Modeling		✓	✓	✓	✓
Rendering, Lights & Materials		✓	✓	✓	✓
3rd Party Application API		✓	✓	✓	✓
3D Constraint Manager		✓	✓	✓	✓
3D Automatic Parametrization		✓	✓	✓	✓
Deformable Modeling Engine		✓	✓	✓	✓
Intelligent PointCloud Filtering		✓	✓	✓	✓
BricsCAD Mechanical Features			✓		✓
Parametric Assembly Modeling			✓		✓
Automatic Bills of Materials Generation			✓		✓
Automatic Exploded View Creation			✓		✓
Robust Sheet Metal Design Workflow			✓		✓
Custom Properties			✓		✓
Smarter piping design			✓		✓
Project Browser				✓	✓
Smarter piping design				✓	✓
The BricsCAD BIM Workflow				✓	✓
BIM-Ready Concept Modeler				✓	✓
QUICKDRAW and AUTOMATCH Tools				✓	✓
Automatic BIM Element Classification				✓	✓
A.I.-based PROPAGATE Workflow				✓	✓
Associative Construction Documentation				✓	✓





Bricsys builds BricsCAD for people who build things. For the past two decades, our singular focus has been making cost-effective, mission-critical CAD, BIM and CDE products. Now a part of the global technology giant Hexagon AB, we are reinforcing our commitment to helping our customers achieve more, in less time, for less money.

[Learn more at www.bricsys.com](http://www.bricsys.com)

Bricsys HQ - Bellevue 5/201, 9050, GENT Belgium



[BricsCAD](#)

[BricsCAD Core](#)

[BricsCAD BIM](#)

[BricsCAD Mechanical](#)

[BricsCAD BIM academy](#)

[BricsCAD Webinars](#)

[BricsCAD TechSupport videos\(INDIA\)](#)

[BricsCAD Hindi Videos](#)

[↓ CADPower Brochure](#)

DesignSense Software Technologies Pvt. Ltd.

#365/8, Hasmitha Avenue 16th Main Road, Jayanagar 4T Block, Bengaluru – 560 041 India.
M: +91-9243438300 / 8073279755 P: +91-80-41625057 | E: rakesh.rao@thedesignsense.com

DesignSense is the official local partner for BricsCAD products